

PLAN

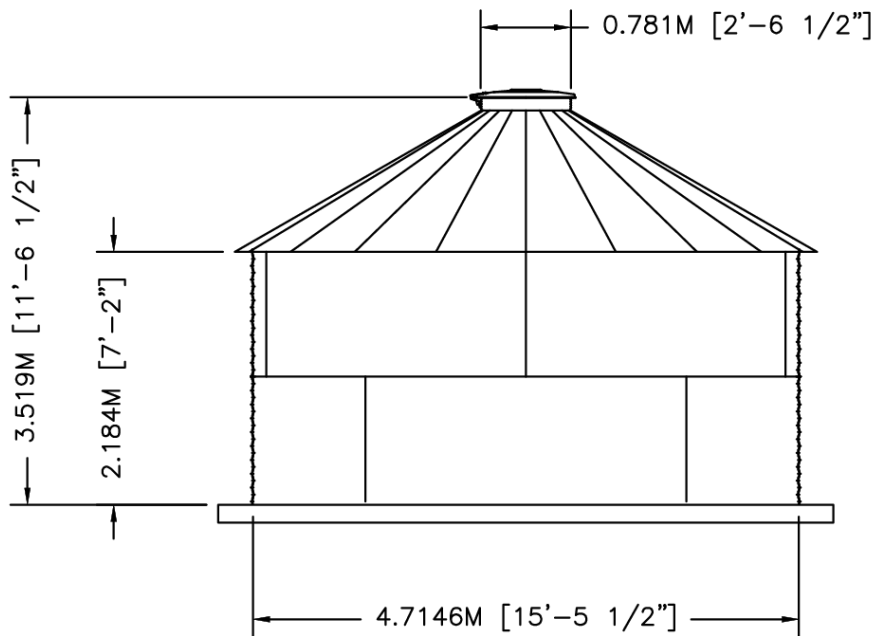

ELEVATION



	BY	DATE	TITLE	
DWN	XXX	XX/XX/XX	WTU05-02 30"PR 30DEG V-RIB	
CKD			NOMINAL CAPACITY - 35.916 M3 [9,488 GAL]	
ENG			DWG. NO. SCT1502-VR WTU05-02	REV. NO.
	SIZE: A	SCALE: 3/16"=1'-0"	SHEET 1	OF 1